

Service
Service
Service



Service Manual



TABLE OF CONTENTS

	Page
Version Variation.....	1-2
Technical specification	1-3..1-14
Safety instruction.....	2-1
ESD protection.....	2-2
Set Block diagram	3-1
Set Wiring diagram.....	4-1
Circuit diagram.....	5-1..5-3
Layout diagram.....	6-1..6-2
Mechanical Exploded view.....	7-1

© Copyright 2012 Philips Consumer Electronics B.V. Eindhoven, The Netherlands
All rights reserved. No part of this publication may be reproduced, stored in a retrieval system or transmitted, in any form or by any means, electronic, mechanical, photocopying, or otherwise without the prior permission of Philips.



Published by LX 1221 Service Audio Subject to modification

3141 785 3821 0

Version 1.0



PHILIPS

2.0 SAFETY INSTRUCTIONS

(GB) WARNING

All ICs and many other semi-conductors are susceptible to electrostatic discharges (ESD). Careless handling during repair can reduce life drastically. When repairing, make sure that you are connected with the same potential as the mass of the set via a wrist wrap with resistance. Keep components and tools also at this potential.

ESD**(NL)** WAARSCHUWING

Alle IC's en vele andere halfgeleiders zijn gevoelig voor electrostatische ontladingen (ESD). Onzorgvuldig behandelen tijdens reparatie kan de levensduur drastisch doen verminderen. Zorg ervoor dat u tijdens reparatie via een polsband met weerstand verbonden bent met hetzelfde potentiaal als de massa van het apparaat. Houd componenten en hulpmiddelen ook op ditzelfde potentiaal.

(F) ATTENTION

Tous les IC et beaucoup d'autres semi-conducteurs sont sensibles aux décharges statiques (ESD). Leur longévité pourrait être considérablement écourtée par le fait qu'aucune précaution n'est prise à leur manipulation. Lors de réparations, s'assurer de bien être relié au même potentiel que la masse de l'appareil et enfilez le bracelet serti d'une résistance de sécurité. Veiller à ce que les composants ainsi que les outils que l'on utilise soient également à ce potentiel.

(D) WARNUNG

Alle ICs und viele andere Halbleiter sind empfindlich gegenüber elektrostatischen Entladungen (ESD). Unsorgfältige Behandlung im Reparaturfall kann die Lebensdauer drastisch reduzieren. Veranlassen Sie, dass Sie im Reparaturfall über ein Pulsarmband mit Widerstand verbunden sind mit dem gleichen Potential wie die Masse des Gerätes. Bauteile und Hilfsmittel auch auf dieses gleiche Potential halten.

(I) AVVERTIMENTO

Tutti IC e parecchi semi-conduttori sono sensibili alle scariche statiche (ESD). La loro longevità potrebbe essere fortemente ridotta in caso di non osservazione della più grande cauzione alla loro manipolazione. Durante le riparazioni occorre quindi essere collegato allo stesso potenziale che quello della massa dell'apparecchio tramite un braccialetto a resistenza. Assicurarsi che i componenti e anche gli utensili con quali si lavora siano anche a questo potenziale.

(GB)

Safety regulations require that the set be restored to its original condition and that parts which are identical with those specified, be used.

"Pour votre sécurité, ces documents doivent être utilisés par des spécialistes agréés, seuls habilités à réparer votre appareil en panne".

(NL)

Veiligheidsbepalingen vereisen, dat het apparaat bij reparatie in zijn oorspronkelijke toestand wordt teruggebracht en dat onderdelen, identiek aan de gespecificeerde, worden toegepast.

**(F)**

Les normes de sécurité exigent que l'appareil soit remis à l'état d'origine et que soient utilisés les pièces de rechange identiques à celles spécifiées.

(GB) Warning !

Invisible laser radiation when open. Avoid direct exposure to beam.

(D)

Bei jeder Reparatur sind die geltenden Sicherheitsvorschriften zu beachten. Der Originalzustand des Geräts darf nicht verändert werden; für Reparaturen sind Original-Ersatzteile zu verwenden.

(S) Varning !

Osynlig laserstrålning när apparaten är öppnad och spårren är urkopplad. Betrakta ej strålen.

(I)

Le norme di sicurezza esigono che l'apparecchio venga rimesso nelle condizioni originali e che siano utilizzati i pezzi di ricambio identici a quelli specificati.

(SF) Varoitus !

Avatussa laitteessa ja suojalukituksen ohitettaessa olet alltiina näkymättömälle laserisäteilylle. Älä katso säteeseen!

"After servicing and before returning set to customer perform a leakage current measurement test from all exposed metal parts to earth ground to assure no shock hazard exist. The leakage current must not exceed 0.5mA."

DK Advarsel !

Usynlig laserstrålning ved åbning når sikkerhedsafbrydere er ude af funktion. Undgå udsættelse for stråling.

Caution: These servicing instructions are for use by qualified service personnel only.

To reduce the risk of electric shock do not perform any servicing other than that contained in the operating instructions unless you are qualified to do so.

2.1 ESD PROTECTION

- レンズには絶対に触れないでください。
- DO NOT TOUCH THE LENS.
- LINSE NICHT BRÜHREN.
- NE PAS TOUCHER LA LENTILLE.

When the power supply is being turned on, you may not remove this laser cautions label. If it removes, radiation of laser may be received.

PREPARATION OF SERVICING

Pickup Head consists of a laser diode that is very susceptible to external static electrocity.

Although it operates properly after replacement, if it was subject to electrostatic discharge during replacement, its life might be shortened. When replacing, use a conductive mat, soldering iron with ground wire, etc. to protect the laser diode form damage by static electricity.

And also, the LSI and IC are same as above.

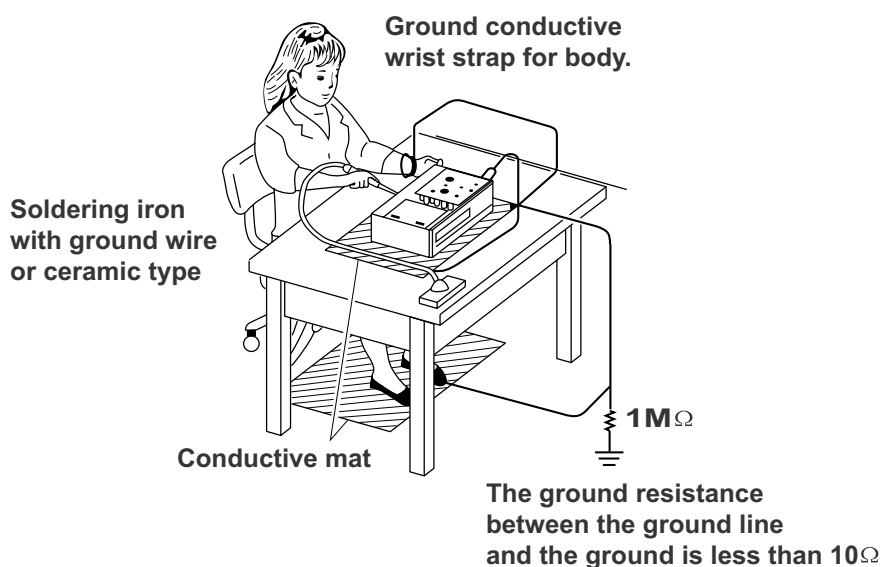

SAFTY NOTICE

SAFTY PRECAUTIONS

LEAKAGE CURRENT CHECK

Plug the AC line cord directly into a 120V AC outlet (do not use an isolation transformer for this check). Use an AC voltmeter, having 5000Ω per volt or more sensitivity. Connect a 1500Ω 10W resistor, paralleled by a $0.15\mu\text{F}$ 150V AC capacitor between a known good earth ground (water pipe, conduit, etc.) and all exposed metal parts of cabinet (antennas, handle bracket, metal cabinet screwheads, metal overlays, control shafts, etc.).

Measure the AC voltage across the 1500Ω resistor. The test must be conducted with the AC switch on and then repeated with the AC switch off. The AC voltage indicated by the meter may not exceed 0.3V. A reading exceeding 0.3V indicates that a dangerous potential exists, the fault must be located and corrected. Repeat the above test with the DVD VIDEO PLAYER power plug reversed. NEVER RETURN A DVD VIDEO PLAYER TO THE CUSTOMER WITHOUT TAKING NECESSARY CORRECTIVE ACTION.

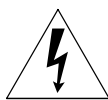
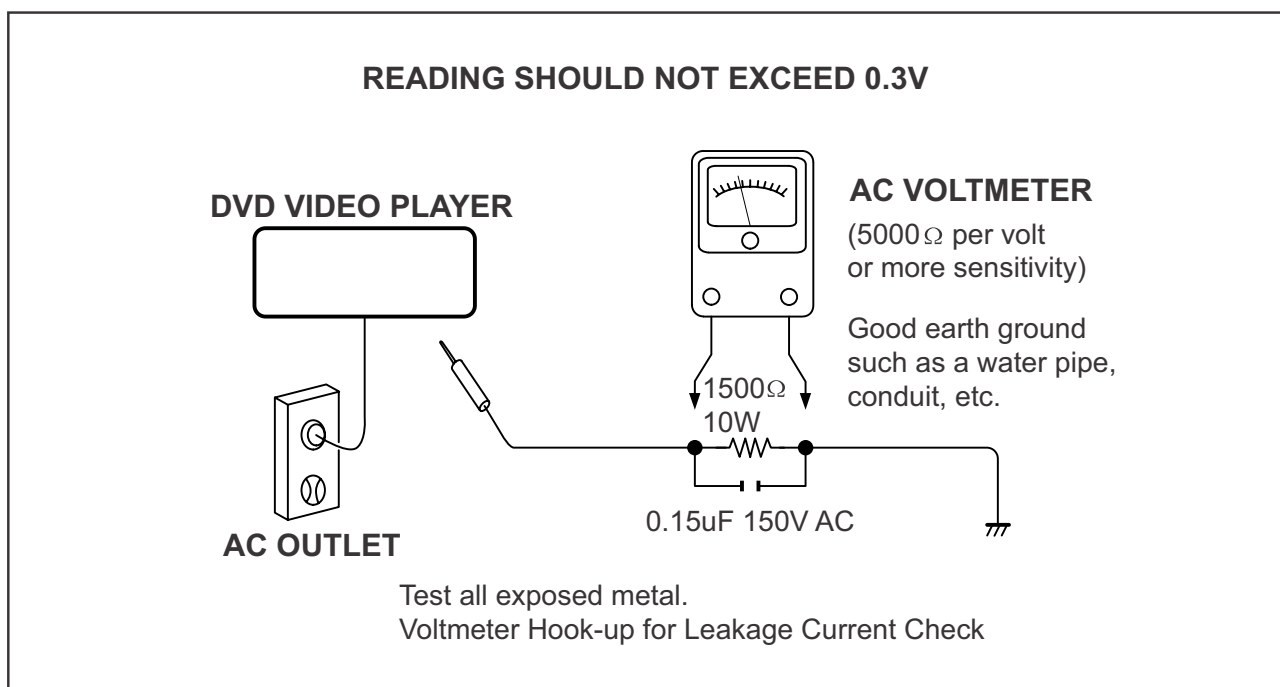

The lightning flash with arrowhead symbol, within an equilateral triangle, is intended to alert the user to the presence of uninsulated "dangerous voltage" within the product's enclosure that may be of sufficient magnitude to constitute a risk of electric shock to persons.



The exclamation point within an equilateral triangle is intended to alert the user to the presence of important operating and maintenance (servicing) instructions in the literature accompanying the appliance.

BLOCK DIAGRAM

3-1

3-1

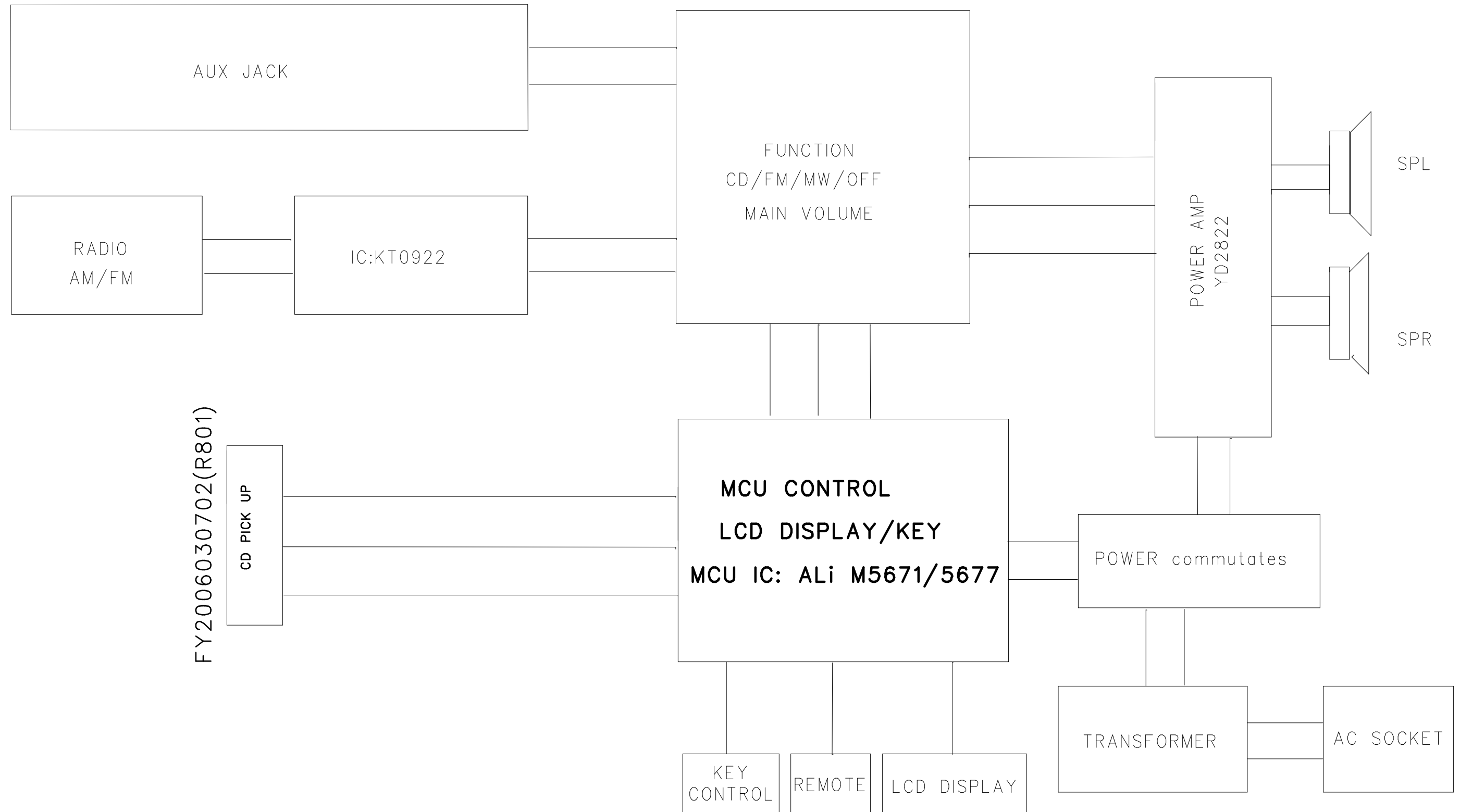

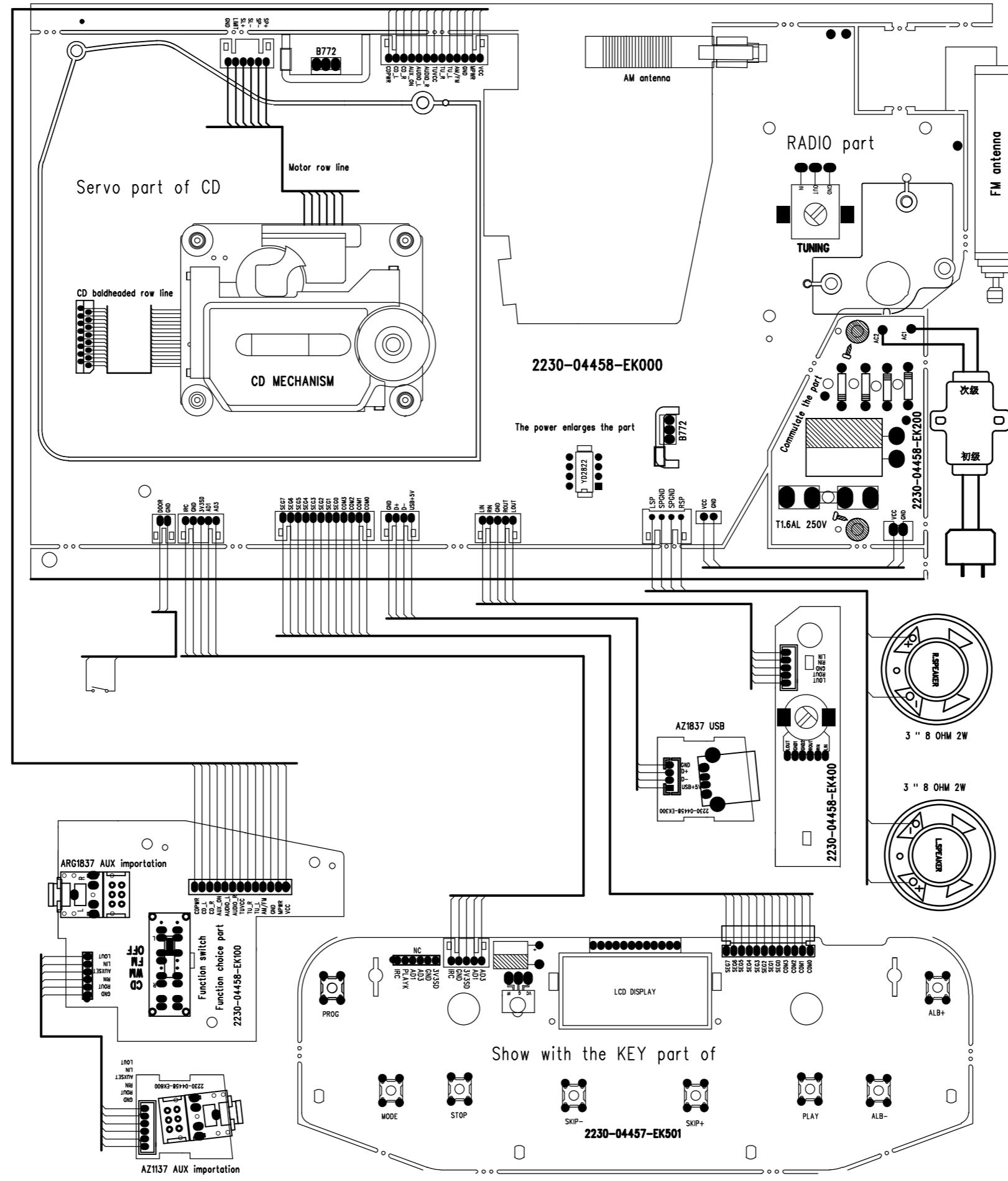

CIRCUIT DIAGRAM- POWER BOARD

5-1

5-1

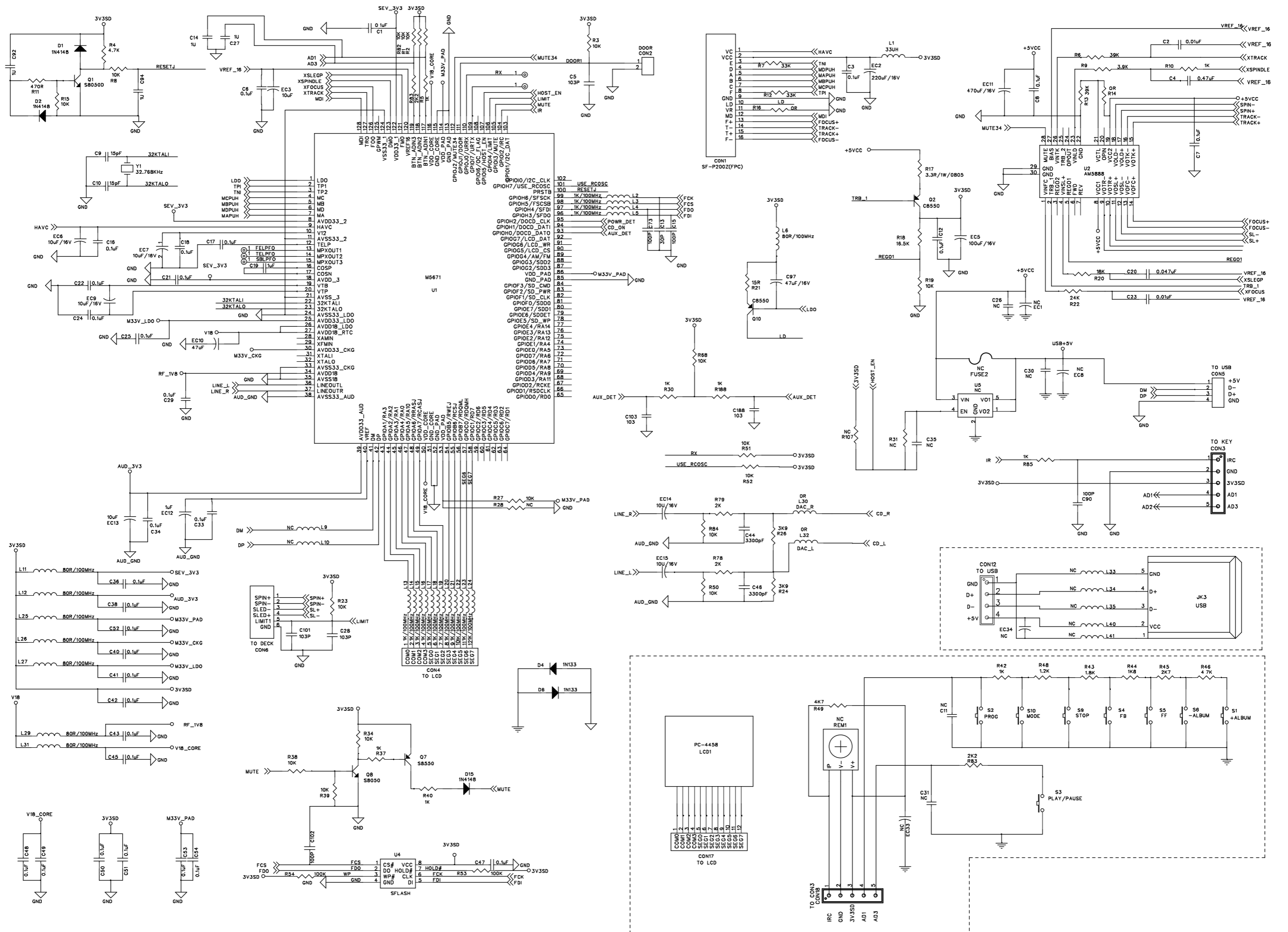

CIRCUIT DIAGRAM - MAIN BOARD

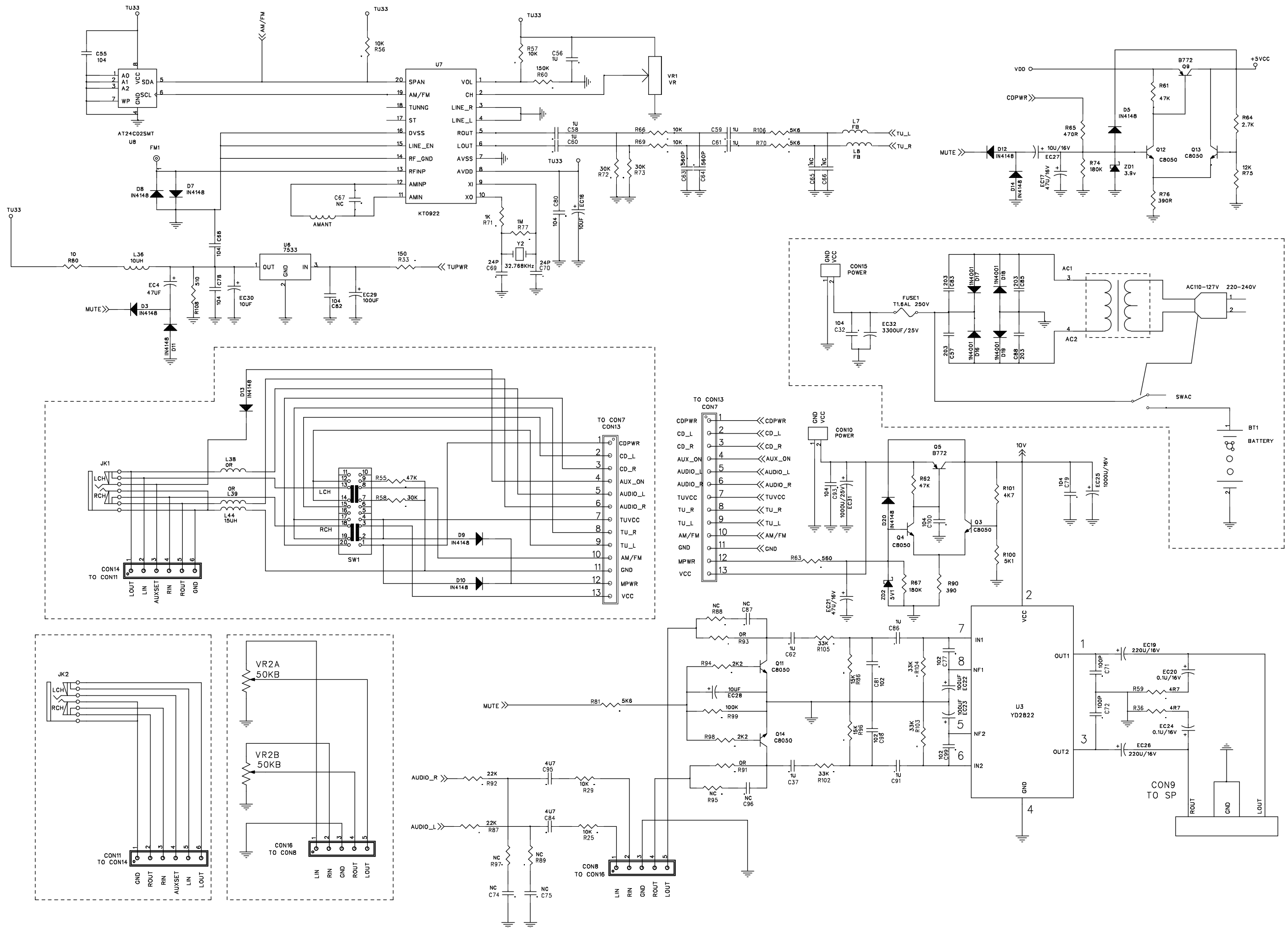

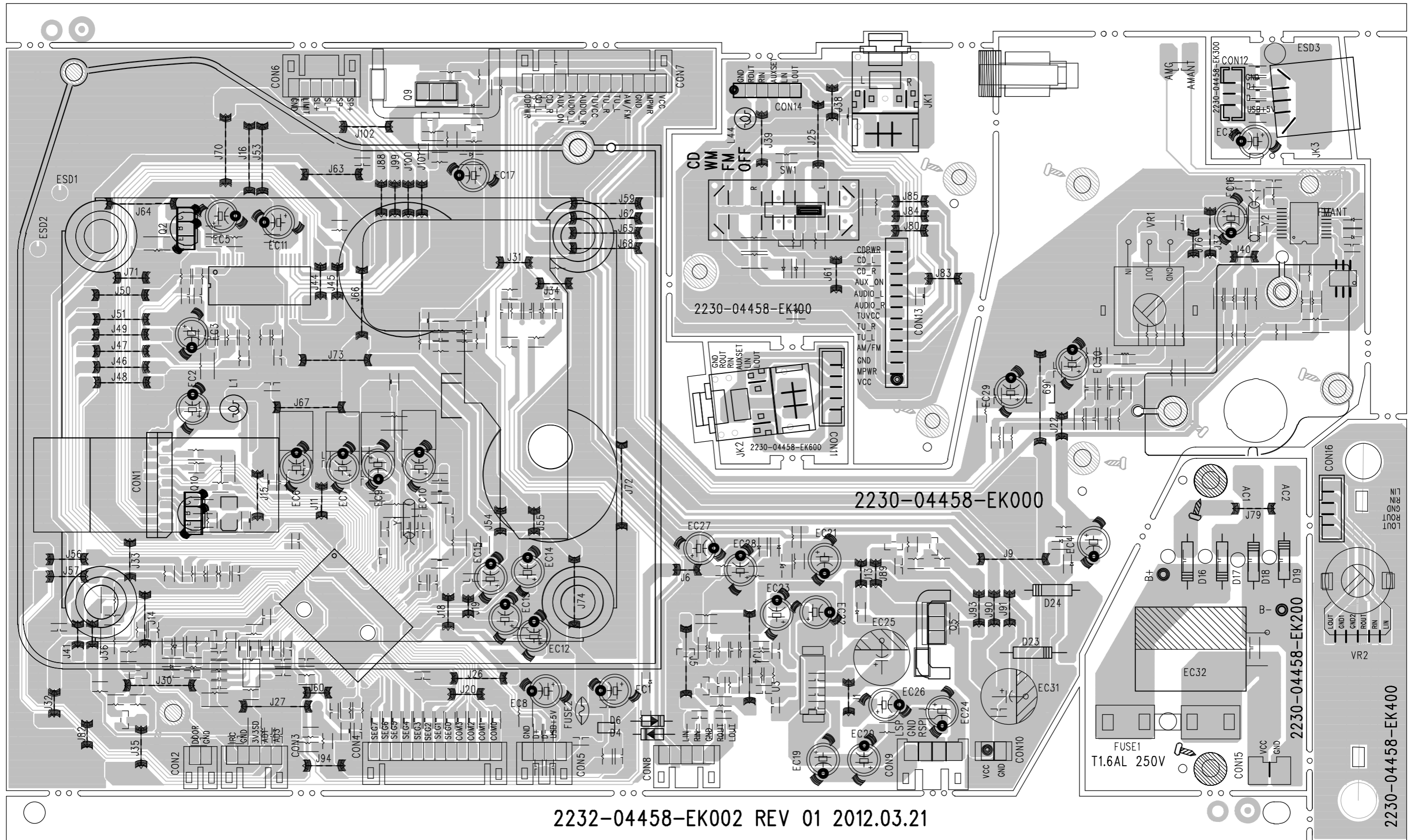

2232-04458-EK002 REV 01 2012.03.21

2230-04458-EK400

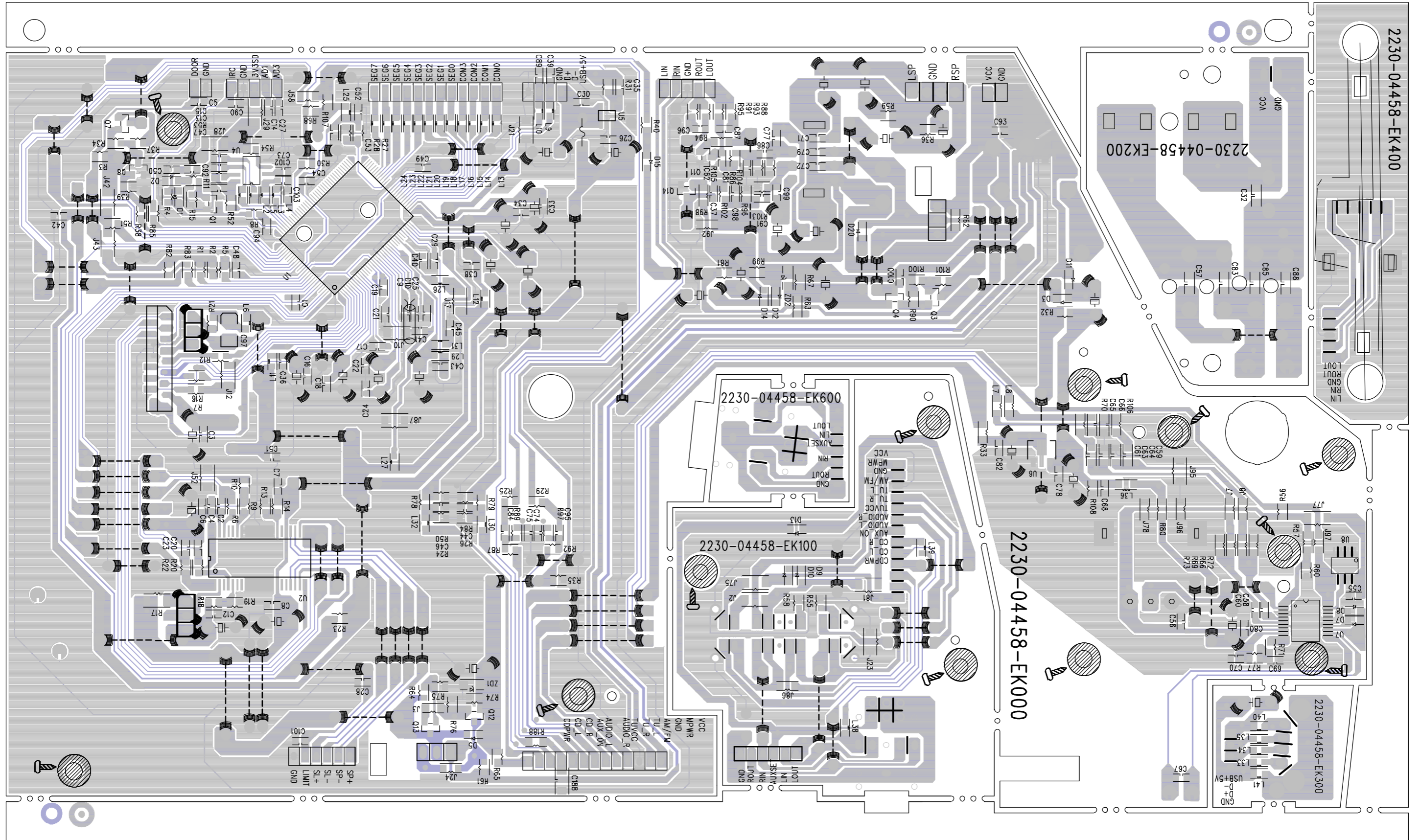

EXPLODE VIEW DIAGRAM

7-1

7-1

